

These drawings and specifications are the exclusive property of Martin International Enclosures, Inc. and shall not be copied, reproduced or used for any purpose at all without prior written permission of Martin International Enclosures, Inc. (MIE) except to manufacture for MIE, Inc. the items on the drawings. These drawings are issued in strict confidence.

REVISION HISTORY			
REV	DESCRIPTION	DATE	APPROVED
A	INITIAL RELEASE		

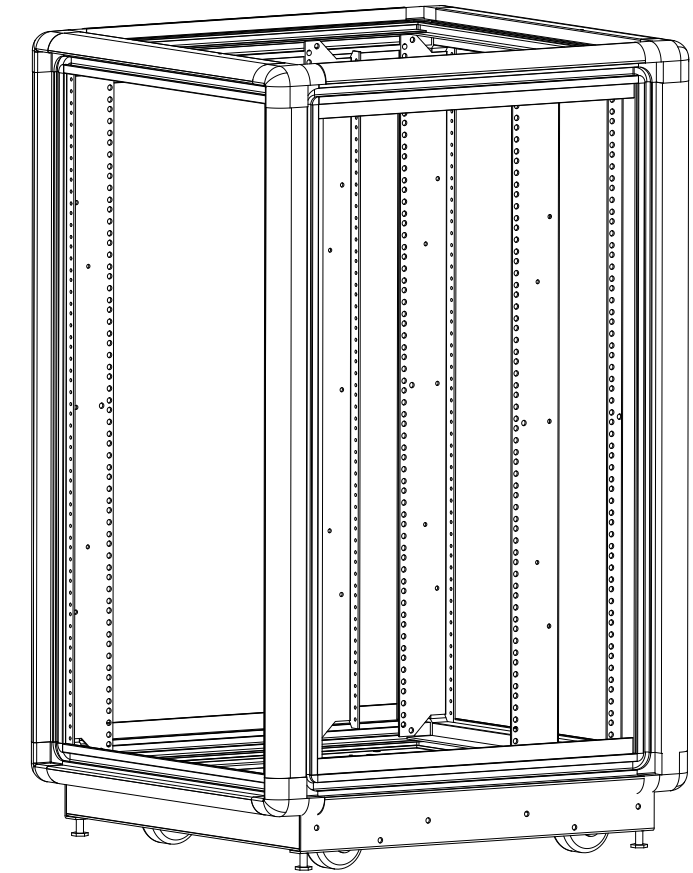
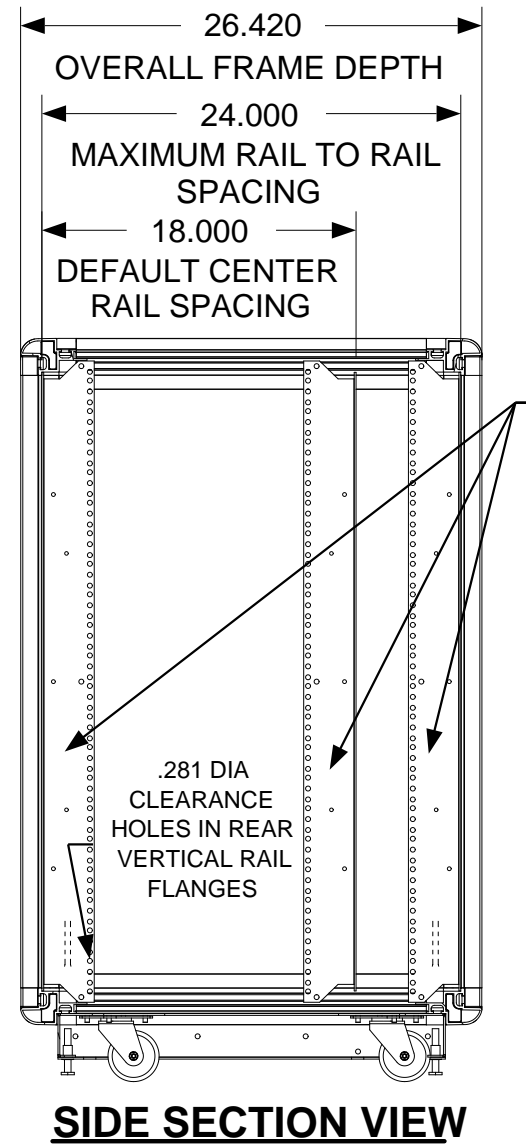
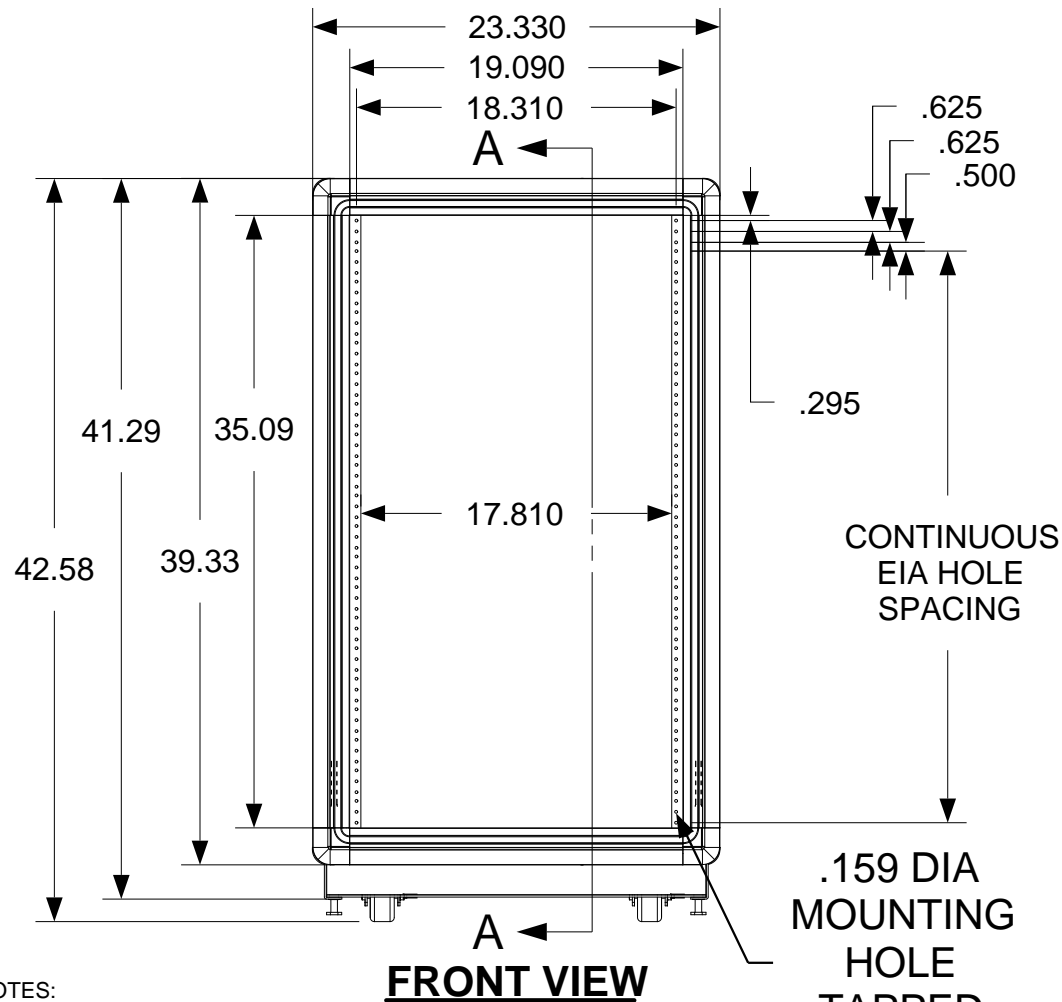
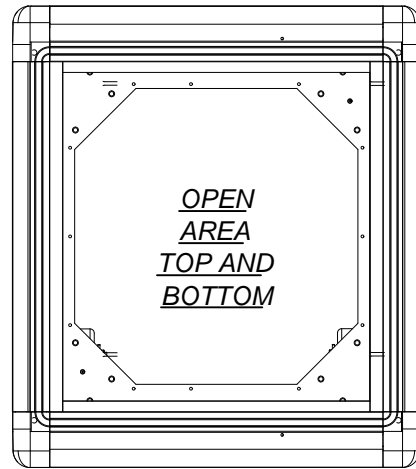

- NOTES:
1) ALL BEND RADIUS .030.
2) DIMENSIONS IN BLOCKS ARE CRITICAL TO FUNCTION.
3) ALL DIMENSIONS ARE OUTSIDE UNLESS NOTED.

MATERIAL					
TOLERANCES EXCEPT AS NOTED DECIMAL .XX = +/- .020 .XXX = +/- .010 ANGULAR +/- 1/2 DEG					
PART NAME		SIZE	DATE	PART #	REV
20U X 24" DEEP; 19" RACKMOUNT EXTRUDED ALUMINUM FRAME		B	8/30/17	351924-TR10	A
PROGRAM#	DATE	DRAWN BY: JQ		SCALE = 1/11	FINISH: A/R
SETBACK=	DATE	APPROVED BY:		SHEET	1 OF 1

ORDER#

NEXT UPPER ASSEMBLY:

PROGRAM#

DATE

SETBACK=

DATE

DRAWN BY: JQ

APPROVED BY:

SIZE
B

DATE
8/30/17

PART #
351924-TR10

REV
A

SCALE = 1/11

FINISH: A/R

SHEET

1 OF 1